

Primární / Sekundární vzduch
Primärluft / Sekundärluft
Primary / Secondary air

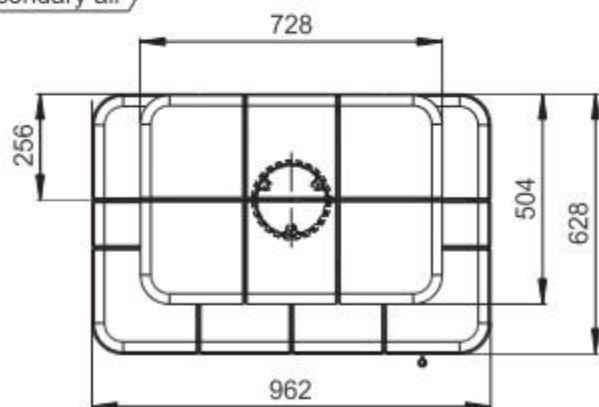

Rozměry v mm
Maße in mm
Dimensions in mm

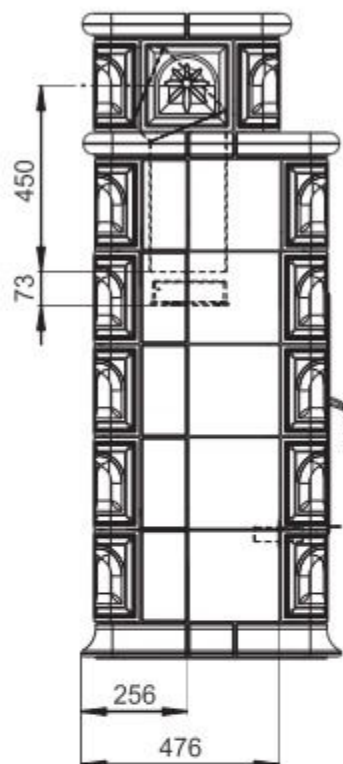

Centrální přívod vzduchu
Zentralluftzufuhr
Central air inlet

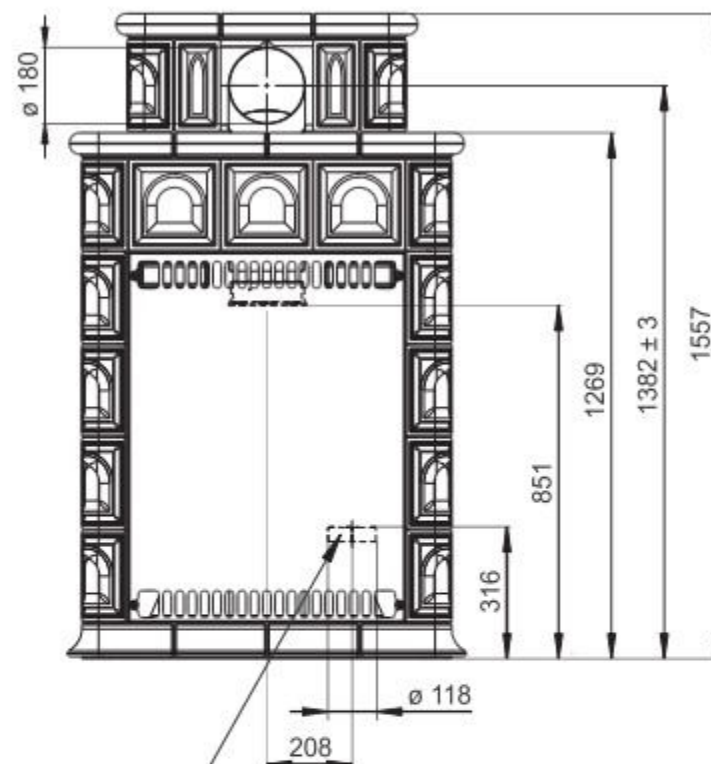

Kachlová kamna Kachelöfen Tiled Stoves	Typ Type Typ	BARACCA 3N	
Hmotnost Gewicht Weight	370 kg	Rozměry topeniště (výška x šířka x hloubka) Maße Feuerraum (höhe x breite x tiefe) Combustion Chamber Dimensions (height x width x depth)	330 x 520 x 300 (mm)
		Hein & spol. - keramické závody, spol. s r. o. Odry - Tošovice	