

Primární / Sekundární vzduch  
Primärluft / Sekundärluft  
Primary / Secondary air

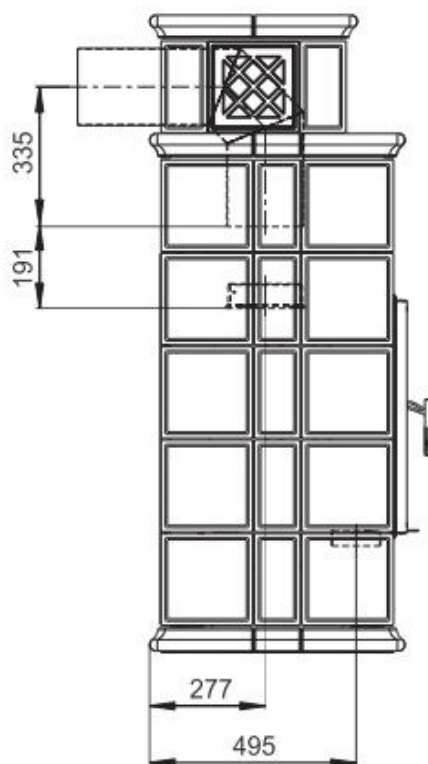

Centrální přívod vzduchu  
Zentralluftzufuhr  
Central air inlet

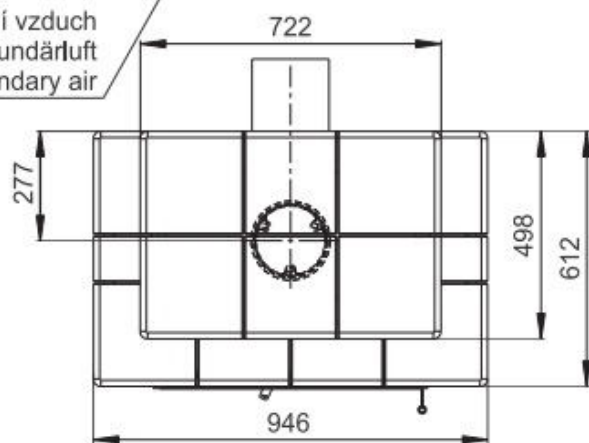
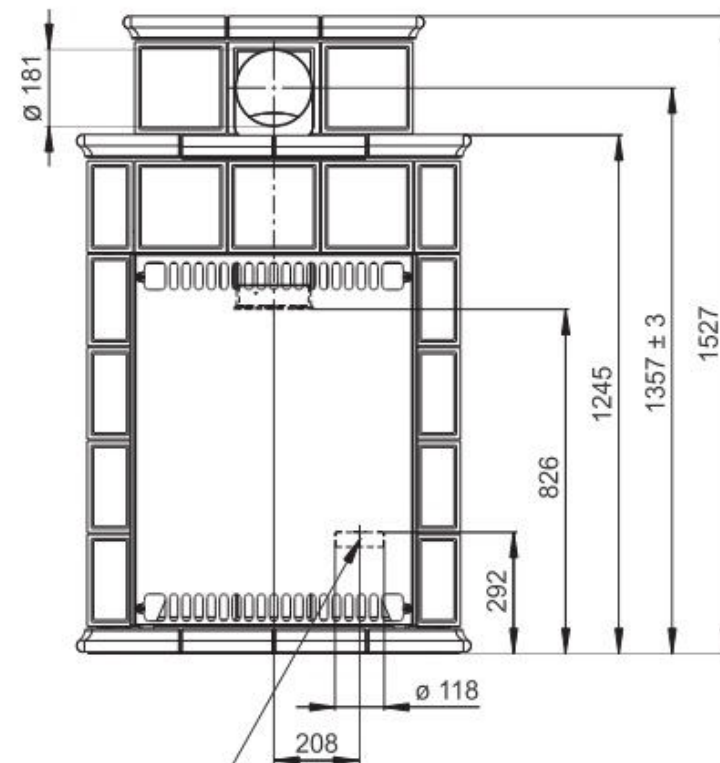

Rozměry v mm  
Maße in mm  
Dimensions in mm

|  |                    |   |                      |
|--|--------------------|---|----------------------|
| Kachlová kamna<br>Kachelöfen<br>Tiled Stoves | Typ<br>Type<br>Typ | <b>BARACCA 9</b>  |                      |
| Hmotnost<br>Gewicht<br>Weight                | 370 kg             | Rozměry topeniště (výška x šířka x hloubka)<br>Maße Feuerraum (höhe x breite x tiefe)<br>Combustion Chamber Dimensions (height x width x depth) | 330 x 520 x 300 (mm) |
|  |                    | Hein & spol. - keramické závody, spol. s r. o.<br>Odry - Tošovice   |                      |